



ANTI-SLIP
SAFETY PRODUCTS

SERVING THE OILFIELD



SafetyGrip Solutions Ltd is one of the UK's leading manufacturers and suppliers of heavy duty anti-slip safety products. Our unique brand of products are specifically designed to eliminate the hazard of slips and trips in the workplace - whether it be Stairways, Drill Floors Ladders, Walkways, Decks or Ramps we offer the solutions that will keep you on your feet.

Our manufacturing facility in Aberdeen, Scotland supplies the Oil, Gas and Marine industries both here in the UK as well as internationally around the globe. We are a solutions based company that understands the needs of our customers, our commitment to product design and development ensures our product offers uncompromised safety at all times.

Our company's expertise and experience is unparalleled and we remain at the forefront of our sector.

Where we work

- Offshore / Onshore Drilling
- Oil and Gas Production
- Marine and Shipping
- Oil Refineries and Terminals
- Offshore Construction



SafetyGrip Solutions brings you the latest in anti-slip safety

Our products are specifically designed to prevent accidents and maintain safety within the work place. We specialise in industrial applications that require that added strength and durability. We take pride in ensuring every product is manufactured to the highest of standards thus enabling long lasting performance for all of our customers.

Engineered and constructed using the latest resin based composite materials that incorporate SafetyGrip's unique diamond hard aggregate surfaces, this ensures an extremely hard wearing and highly robust product that will prove to be highly effective even after many years of use.

We currently offer anti-slip solutions for a wide range of industrial applications.

Stairway Safety	Pages 4-7
Walkways and Decks Safety	Pages 8-13
Pipe and Hose Ramps Safety	Pages 14-15
Ladder Safety	Pages 16-17
Gangway Safety	Pages 18-19
Safety Tapes	Pages 20-21
Technical Information	Pages 22-23

Applications

- Stairways and Landings
- Ladders and Gangways
- Walkways
- Grating Decks/Mezzanines
- Rig Drill Floors
- Access Ramps
- Tanks and Tank Covers
- Pipe and Hose Ramps

Key Features

- High Traction
- Heavy Duty and Hard Wearing
- Standard and Custom Sizes
- Easy and quick Installation
- Excellent Impact Resistance
- Fire Retardancy
- High Visibility
- Non Corrosive and Chemical Resistant

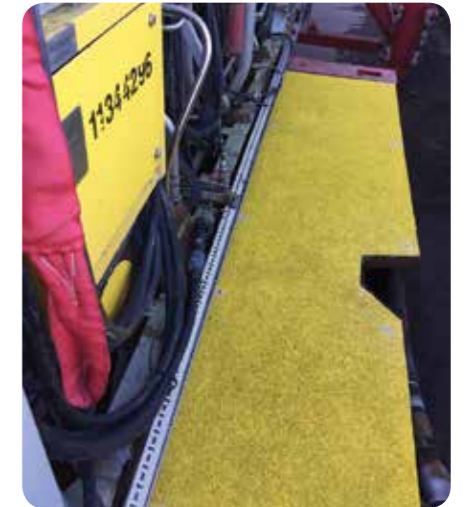



Anti-slip Stair Treads

Standard Treads and Signage Treads

SafetyGrip Solutions manufacture an extensive range of anti-slip stair treads which are designed to be installed (retro fitted) directly onto your existing stairs. These heavy duty treads will provide an excellent high traction surface even in the harshest of conditions

Benefits and Features

The leading edge of steps can quickly wear leaving a smooth and slippery surface, add in the effects of oil, grease or mud and very quickly you will find that you have created a hazardous situation. Quick and easy to install these high traction treads you will drastically improve the walking surface which will contribute to the increased safety of personnel.

Applications

Standard Tread Applications

We offer a wide range of standard anti-slip stair treads, stair nosings and landing covers. SafetyGrip treads can be supplied for various applications, standard sizes along with custom bespoke applications, our speciality.

Signage Tread Applications

Why not further enhance your site safety by adding signage to your step covers. A wide range of treads which include advisory notices, safety critical messages and company logos are available - fully bespoke to meet your own specification.

KEY FEATURES

- Heavy Duty/High Traction
- Non Corrosive
- High Impact Resistance
- Standard and Custom Sizes
- Easy installation
- Fully Guaranteed
- Easy to Clean

SPECIFICATIONS

Sizes

As well as standard sizing SafetyGrip can manufacture and supply anti-slip treads pre-cut to the customer's exact specifications at no extra cost, just let us know your requirements and we will be happy to accommodate your needs.

		STANDARD SIZES							
A	B	(4") 100mm	(6") 150mm	(8") 200mm	(10") 250mm	(12") 300mm	(14") 350mm	(16") 400mm	(18") 450mm
(18") 450mm		✓	2	✓	2	✓	2	✓	4
(24") 600mm		✓	2	✓	2	✓	2	✓	4
(30") 750mm		✓	3	✓	3	✓	3	✓	6
(36") 900mm		✓	3	✓	3	✓	3	✓	6
(42") 1050mm		✓	4	✓	4	✓	4	✓	8
(48") 1200mm		✓	4	✓	4	✓	4	✓	8

(number indicates recommended fixing quantities)

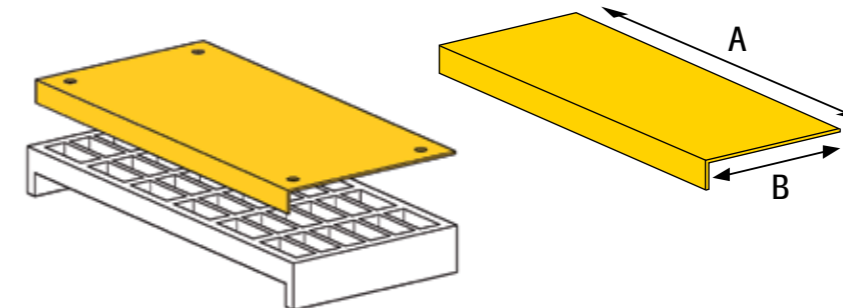

Surface Grades

We offer a choice of 3 surface grades of - the grade determines the size of grit used.

SURFACE GRADES	CODE	GRIT SIZE	APPLICATION
Fine	FG	2mm (1/16")	Light Industrial
Coarse	CG	4mm (3/16")	General Industrial
Extra Coarse	XCG	6mm (1/4")	Heavy Duty Industrial

Colour Coding / Hazard Markings

Select from a wide range of high visibility colours including two tone colour options that will highlight the leading edge of the step.

We also offer HiGlo photoluminescent finishes that will be visible for several hours after the light is removed.

Installation

The treads are designed for ease of installation and can be installed onto a variety of different surfaces, whether you opt for mechanical fixings or adhesive we offer the full range of hardware to ensure a safe and secure fit.

- Grating / Grille Stairs - Saddle clip assembly
- Chequered / Diamond Stairs - Nut / Bolt / Washer, Screws
- Concrete Stairs - Hammer Fixings
- Timber Stairs - Wood Screws





Anti-slip Stair Treads

Spiral Treads and Riser Treads

SafetyGrip Solutions offer a range of anti-slip stair covers that include both Spiral stair treads and Riser plate treads, both these types of anti-slip tread are custom made and designed to be installed (retro fitted) directly onto your existing stairs. These heavy duty treads will provide an excellent high traction surface even in the harshest of conditions.

Benefits and Features

The leading edge of steps can quickly wear leaving a smooth and slippery surface, add in the effects of oil, grease or mud and very quickly you will find that you have created a hazardous situation. Quick and easy to install these high traction treads you will drastically improve the walking surface which will contribute to the increased safety of personnel.

Applications

Spiral Tread Applications

SafetyGrip offer a full range of spiral treads that can be custom moulded to your exact specifications, we offer options for both right and left turning stairs and they can be applied to almost every type of surface.

Riser Treads Applications

SafetyGrip riser treads are designed to combine a safety riser plate at the rear of the step, this allows the step to be fully enclosed and will prevent any loose objects from passing through the stair onto the deck below - a proven solution to reduce and eliminate dropped object incidents.

KEY FEATURES

- Heavy Duty/High Traction
- Non Corrosive
- High Impact Resistance
- Standard and Custom Sizes
- Easy installation
- Fully Guaranteed
- Easy to Clean

SPECIFICATIONS

Sizing

As well as standard sizing SafetyGrip can provide full customized applications at no extra cost, just let us know your requirements and we will happy to accommodate your needs. (Note: Anti-slip Riser treads need to be supplied at the full length and breadth of the step to be fully affective).

Surface Grades

We offer a choice of 3 surface grades - the grade determines the size of grit used.

Riser Tread

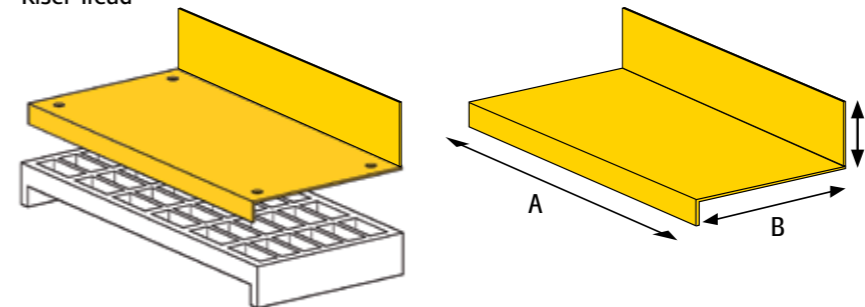

Spiral Tread

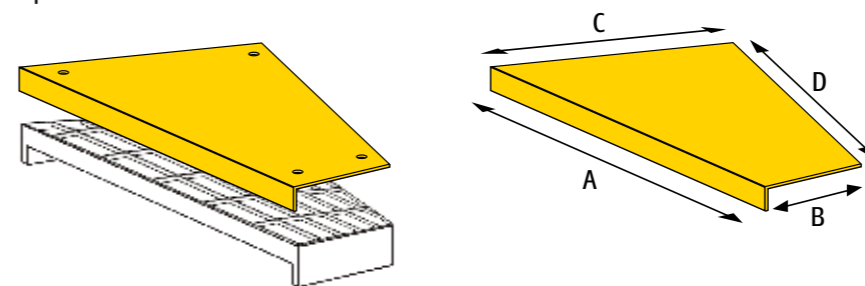

SURFACE GRADES	CODE	GRIT SIZE	APPLICATION
Fine	FG	2mm (1/16")	Light Industrial
Coarse	CG	4mm (3/16")	General Industrial
Extra Coarse	XCG	6mm (1/4")	Heavy Duty Industrial

Colour Coding / Hazard Marking

Select from a wide range of high visibility colours including two tone colour options that will highlight the leading edge of the step. We also offer Hi-Glo photo luminescent finishes that will be visible for several hours after the light is removed.

These Anti-slip covers can incorporate and signage / logo's that you may require.

Installation

The treads are designed for ease of installation and can be installed onto a variety of different surfaces, whether you opt for mechanical fixings or adhesive we offer the full range of hardware to ensure a safe and secure fit.

- Grating / Grille Stairs - Saddle clip assembly
- Chequered / Diamond Stairs - Nut / Bolt / Washer, Screws
- Concrete Stairs - Hammer Fixings
- Timber Stairs - Wood Screws

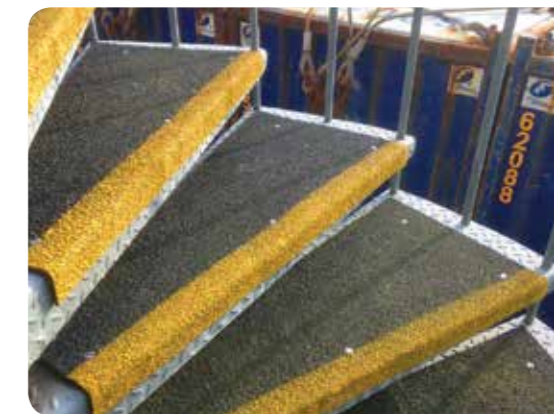

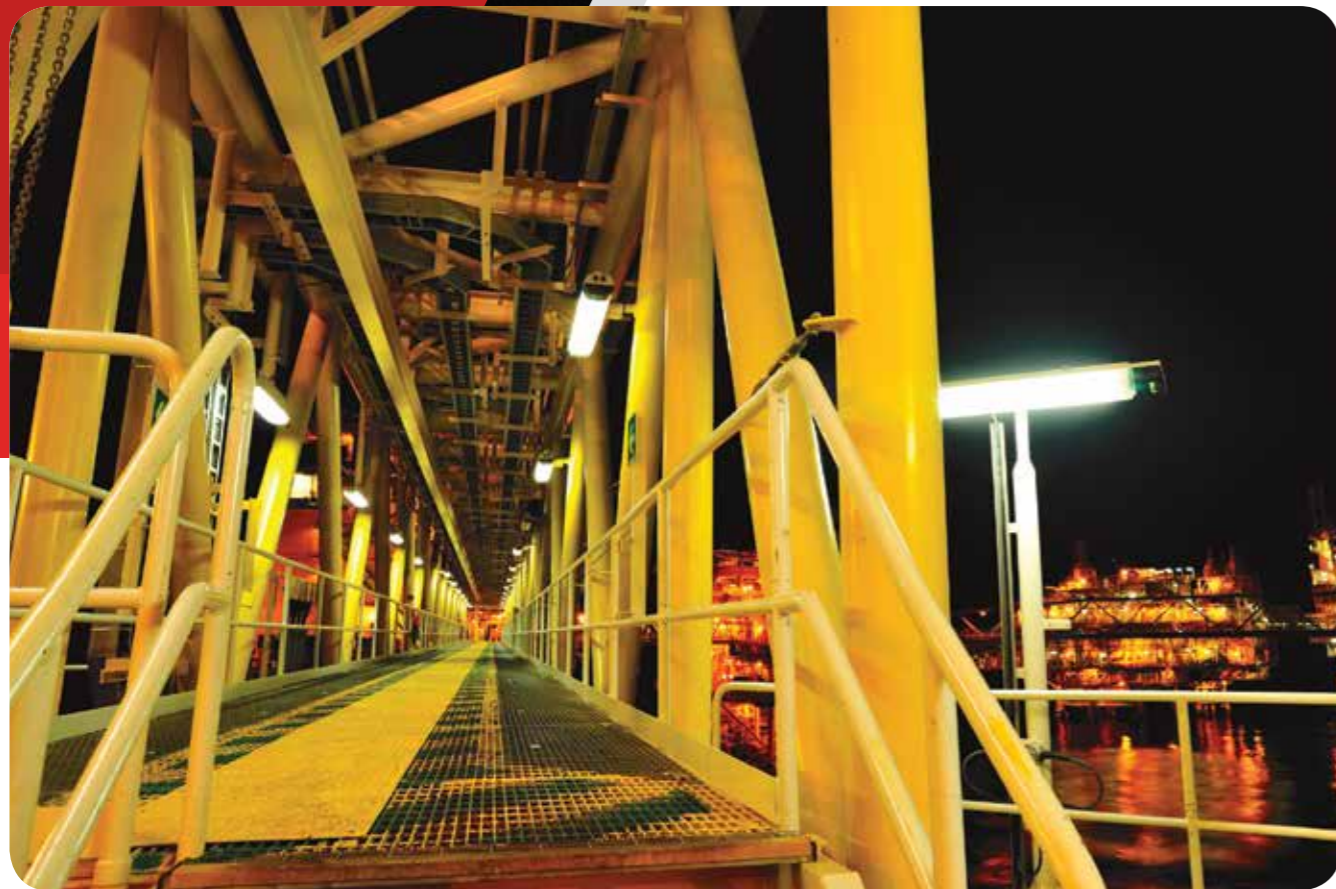

Anti-slip Walkway/Deck Tiles

SafetyGrip Solutions manufacture an extensive range of anti-slip floor tiles which are designed to be installed directly onto your existing walkway/deck surfaces. These heavy duty anti-slip GRP sheets will provide an excellent high traction surface even in the harshest of conditions. Whether it be walkways, decks, ramps or drill floors we have the solutions to keep you on your feet.

WALKWAYS DECKS ACCESS RAMPS DRILL FLOORS MEZZANINES

Benefits and Features

With so many differing types of floor surfaces out there - and with each posing their own particular hazard it is vital to find and choose the correct anti-slip surface. SafetyGrip Solutions have developed a range of anti-slip sheeting which is both quick and easy to install whilst remaining very tough and durable. We can also ease the installation even further by preparing every sheet thus reducing costly downtime onsite.

KEY FEATURES

- Heavy Duty/High Traction
- Non Corrosive
- High Impact Resistance
- Standard and Custom Sizes
- Easy installation
- Fully Guaranteed
- Easy to Clean

Applications

Walkways, Decks and Ramps: (WD1)

Our WD1 product is designed for application onto walkways, deck and access ramps. Manufactured to a thickness of 3-5mm this sheet maintains a certain flexibility which allows it to conform to any un-even deck surfaces. The heavy duty construction ensures superb impact resistance and they provide an excellent pedestrian surface. (Can be installed to steel, timber or concrete surfaces - screwed, welded or bonded)

Mezzanines and Grating Decks: (WD2)

Manufactured to a thickness of 5-7mm, these covers are slightly thicker to increase the strength and durability, ideal for non-solid surfaces like grating or mezzanine decks. This tile is heavy duty and has superb impact resistance - they will provide an excellent pedestrian surface. (Can also be fitted to hard deck areas for forklift trucks, etc.) (Fixed with saddle clip assemblies or welded)

Drill Floors: (WD3)

These tiles are manufactured to a thickness of 7-10mm. A heavy duty tile which contains extra reinforcement to cope with the extreme demands and rigours of an active drill floor - extremely high impact resistance to handle heavy pipe handling and equipment. (Install on both timber and plated decks - screwed or welded)

SPECIFICATIONS

STANDARD SIZES				
Width/Length	500mm	750mm	1000mm	1250mm
1000mm	✓	✓	✓	✓
1500mm	✓	✓	✓	✓
2000mm	✓	✓	✓	✓
2500mm	✓	✓	✓	✓

Standard and Custom Sizes:

In addition to our full range of standard sizes we also offer custom manufacture to your specific requirements. All our tiles can be ordered pre-cut and shaped for ease of installation.

Surface Grade

Our anti-slip covers are manufactured in a choice of 3 grades depending on your requirements - the grade determines the size of grit used.

SURFACE GRADES	CODE	GRIT SIZE	APPLICATION
Fine	FG	2mm (1/16")	Light Industrial
Coarse	CG	4mm (3/16")	General Industrial
Extra Coarse	XCG	6mm (1/4")	Heavy Duty Industrial

Colour Coding / Hazard Marking

We offer a wide range of colours which include: safety yellow, black and yellow, blue, green, grey and red. We can also incorporate high glow fluorescent and photo luminescent finishes. In addition we can also incorporate any type of safety/hazard or warning marking.

Installation

We offer various options for installation depending on product type and location.

PRODUCT FIXING METHOD

- Plated Decks - Bonding or Welding
- Grated Decks - Mezzanines - Saddle clip assemblies
- Concrete - Hammer Fixings
- Timber - Wood screws





Anti-slip Route Markers

SafetyGrip Solutions manufacture an extensive range of anti-slip route markers which are designed to be installed directly onto your existing walkway/deck surfaces. These heavy duty anti-slip strips will provide an excellent high visibility/high traction surface even in the harshest of conditions. Whether it be walkways, decks, or ramps we have the solutions to keep you on your feet.

WALKWAYS DECKS ACCESS RAMPS DRILL FLOORS MEZZANINES

Benefits and Features

With so many differing types of floor surfaces out there - and with each posing their own particular hazard SafetyGrip Solutions have developed a range of anti-slip walkway markers which are designed to direct personnel along designated walkways and escape routes around your facility. Thus contributing to the increased safety all round. Quick and easy to install whilst remaining very tough and durable SafetyGrip Route Markers can be installed directly onto open grating areas where tradition paints cannot be used.

KEY FEATURES

- Heavy Duty/High Traction
- Non Corrosive
- High Impact Resistance
- Standard and Custom Sizes
- Easy installation
- Fully Guaranteed
- Easy to Clean

Applications

Hard Solid Deck

SafetyGrip offer a range of anti-slip marker strips that can be directly fitted to your existing hard deck surfaces, options for steel, concrete and timber surface available. SafetyGrip Marker Strips can be used in conjunction with pre-painted walkways to introduce high visibility colours. Installation can be achieved using Adhesives / Screws / Welding tab, and are available in a number of standard sizes.

Open Grating

SafetyGrip offer a range of anti-slip marker strips that can be directly fitted to your existing open grating surfaces, these are particular helpful when it's not possible to paint the grating surface in the traditional manner, route marker can achieve a quick and effective method to highlight your walkway. Options for securing in place can include Mechanical fixings or Welding tabs and are available in a number of standard sizes.

SPECIFICATIONS

Width/Length	STANDARD SIZES			
	1000mm	1500mm	2000mm	2500mm
50mm	✓	✓	✓	✓
75mm	✓	✓	✓	✓
100mm	✓	✓	✓	✓

Sizing

As well as a full range of standard sizes SafetyGrip can offer customized applications to suit your individual needs, let us know your requirement and we will be happy to accommodate your request, bespoke applications are our speciality.

Surface Grades

We offer a choice of 2 surface grades of Fine and Coarse.

SURFACE GRADES	CODE	GRIT SIZE	APPLICATION
Fine	FG	2mm (1/16")	Light Industrial
Coarse	CG	4mm (3/16")	General Industrial

Colour Coding / Hazard Marking

Select from a wide range of high visibility colours including Hi-Glo Fluorescent and Photoluminescent finishes, these Hi-Glo finishes will remain visible for several hours after the light source has been removed.

Installation

We offer various options for installation depending on product type and location.

PRODUCT FIXING METHOD

- Plated Decks - Bonding or Welding
- Grated Decks - Mezzanines - Saddle clip assemblies
- Concrete - Hammer Fixings
- Timber - Wood screws

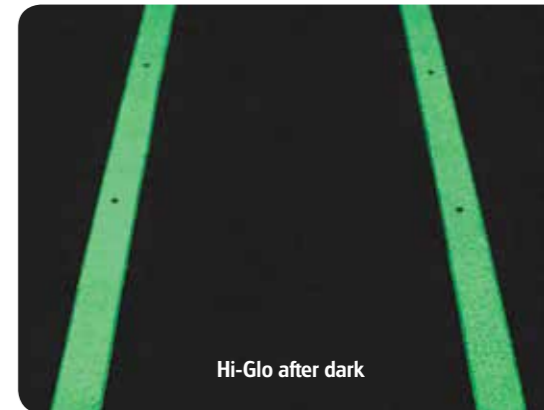



Anti-slip Flexi-Grip

SafetyGrip Solutions manufacture a range of anti-slip flexi-grip floor coverings which are designed to be installed directly onto your existing walkway/deck surfaces. These flexible anti-slip sheets will provide an excellent high traction surface even in the harshest of conditions. Whether it be walkways, decks, or ramps we have the solutions to keep you on your feet.

WALKWAYS DECKS ACCESS RAMPS MEZZANINES

Benefits and Features

With so many differing types of floor surfaces out there - and with each posing their own particular hazard it is vital to find and choose the correct anti-slip surface. SafetyGrip Solutions has developed a range of flexi-grip tiles which are supplied in a roll format to ensure they are easy to handle and install, Flexi-grip can be used quickly to create a convenient and safe anti-slip surface. Flexi-Grip is constructed from a FRP material which ensures toughness and durability in an industrial environment.

KEY FEATURES

- Heavy Duty/High Traction
- Non Corrosive
- High Impact Resistance
- Standard and Custom Sizes
- Easy installation
- Fully Guaranteed
- Easy to Clean

Applications

Flexi-Grip rolls are ideal for creating temporary high traction anti-slip surfaces. These rolls can be quickly applied to most substrates and can be particularly beneficial where the surface is not entirely flat. As the name suggests flexi-grip is designed to hold a certain amount of flexibility which allows it to conform to any un-even deck surfaces.

Being lightweight it is ideal for removal at a later date for cleaning or storage.

As well as temporary surfaces Flexi-Grip is also suitable for more permanent application, they can be attached to most substrate with mechanical fixings and adhesives and will provide a long term solution to any slippery hazardous surfaces.

SPECIFICATIONS

STANDARD SIZES			
Width/Length	2500mm	5000mm	7500mm
800mm	✓	✓	✓
1000mm	✓	✓	✓
1200mm	✓	✓	✓

Standard and Custom Sizes:

In addition to our full range of standard sizes we also offer customized manufacture to your specific requirements.

Surface Grade

Flexi-Grip Rolls are manufactured in a choice of 2 grades depending on your requirements - the grade determines the size of grit used.

SURFACE GRADES	CODE	GRIT SIZE	APPLICATION
Fine	FG	2mm (1/16")	Light Commercial
Coarse	CG	4mm (3/16")	General Industrial

Colour Coding / Hazard Marking

We offer a wide range of colours which including two tone high visibility and photoluminescent colours.

In addition we can also incorporate various logos / hazard identification markings / safety symbols onto the surface of the roll.

Installation

We offer various options for installation depending on product type and location.

PRODUCT FIXING METHOD

- Plated Decks - Bonding or Welding
- Grated Decks - Mezzanines - Saddle clip assemblies
- Concrete - Hammer Fixings
- Timber - Wood screws



Safety for Pipe Ramps



Pedestrian Pipe / Hose Ramps

SafetyGrip Solutions manufacture a range of heavy duty anti-slip Pipe and Hose Ramps. Each ramp is designed with dual purpose in mind as they offer both high traction surfaces to ensure safe pedestrian access whilst simultaneously acting as protective covers for the pipes and hoses that they bridge.

Benefits and Features

Pipes and hoses that straddle the decks can pose a particular danger to personnel, in addition to the obvious trip hazard they can become vulnerable to accidental damage which may result in additional hazards. Our ramps are quick and easy to use and provide a safe and effective method for straddling obstacles whilst ensuring a safe route for personnel.

Each ramp is heavy duty and extremely robust whilst still remaining lightweight enough to be mobile, therefore it can be used in multiple locations around the work site. (Permanent fitting can also be accommodated).

Applications

Typically designed for pedestrian use they can accommodate small bore Pipe, Hoses and Cables up to 200mm (8") in diameter, they are also available in a combination of styles and standard sizes.

Additional larger custom sizes may also be available.

KEY FEATURES

- Heavy Duty/High Traction
- Non Corrosive
- High Impact Resistance
- Standard and Custom Sizes
- Easy installation
- Fully Guaranteed
- Easy to Clean

SPECIFICATIONS

Sizes

SafetyGrip Solutions range of Pipe and Hose Ramps are available in two styles and available in several standard sizes, each cover is a metre in length and can accommodate either a single or double pipe/hose. These ramps are load tested to 250kg. Choose your style depending on your needs.

We also offer custom made products to accommodate any unusual sizes or specifications that you may require.

	STANDARD SIZES	
	Single (SPR)	Double (DPR)
25mm (1")	✓	✓
50mm (2")	✓	✓
100mm (4")	✓	✓
150mm (6")	✓	✓
200mm (8")	✓	✓

Single Ramps

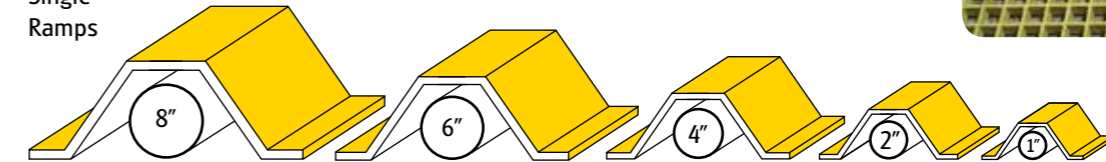

Double Ramps

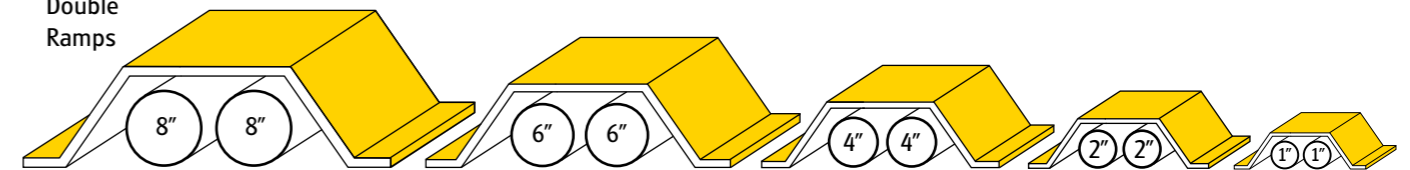

Colour Coding / Hazard Marking

Typically these products are supplied in Hi-visibility safety yellow, or with black and yellow chevrons. We also offer a wide range of additional colours to choose from including High-glow fluorescent and photoluminescent finishes.

Installation

These lightweight ramps are simply placed over the hazard - if you do require a more permanent solution we can integrate fixing points in the ramps to allow for mechanical fixing.

Vehicular Hose / Cable Ramps

SafetyGrip can design and manufacture a range of extra heavy duty anti-slip Hose and Cable Ramps. These ramps can be located where vehicular traffic may be present - including forklift trucks up to 5 tonnes.

These ramps provide suitable protection for any high pressure hoses or cabling that may be running across the floor - we can produce these to a number of custom sizes and fully tailored to your own specification.

Supplied with coarse grade grit for maximum traction, and high visibility markings to ensure it is seen.





Ladder Rung Covers

SafetyGrip Solutions manufacture a range of Anti-slip Ladder Rung Covers which are designed to be installed directly onto your existing ladders. These heavy duty anti-slip covers provide excellent traction even in the harshest of conditions.

Benefits and Features

Accessing and climbing vertical ladders can be hazardous at the best of times, add in the effect of smooth and slippery rungs along with contaminants like oil, grease and mud and they can quickly become very dangerous. By installing our high traction ladder covers you drastically improve the grip on your ladders ensuring a safe method of ascending/descending for personnel.

Applications

Anti-slip Ladder Rung Covers can be supplied to suit the profile of your rungs - we offer both square and round rungs as standard but can also accommodate those unusual shapes and sizes that you may encounter.

KEY FEATURES

- Heavy Duty/High Traction
- Non Corrosive
- High Impact Resistance
- Standard and Custom Sizes
- Easy installation
- Fully Guaranteed
- Easy to Clean

SPECIFICATIONS

Standard and Custom Sizes

SafetyGrip offer a comprehensive range of standard size ladder rung covers for both round and square bar profile, in addition we can produce a wide selection of customized applications to suit the customers individual needs.

		STANDARD SIZES (Round & Square Bar)					
A	B	20mm	22mm	25mm	30mm	40mm	50mm
250		✓	✓	✓	✓	✓	✓
300		✓	✓	✓	✓	✓	✓
350		✓	✓	✓	✓	✓	✓
400		✓	✓	✓	✓	✓	✓
450		✓	✓	✓	✓	✓	✓

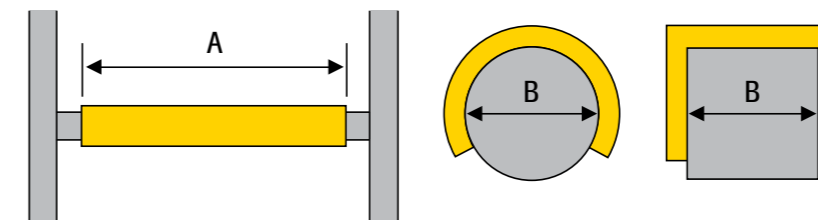

Surface Grade

Our Anti-slip Rung Covers are manufactured to incorporate a fine grade surface - these will provide adequate traction even in the harshest of conditions.

SURFACE GRADES	CODE	GRIT SIZE	APPLICATION
Fine	FG	2mm (1/16")	Light Commercial

Colour Coding

Typically these products are supplied in Hi-visibility safety yellow, although we do offer a wide range of additional colours to choose from: black and yellow, blue, green, grey and red.

We also offer high glow fluorescent and photo luminescent finishes.

Installation

These Anti-slip Ladder Rung Covers are designed to be bonded to the existing ladder rung bar - all our rungs are supplied with high grade polyurethane adhesives to ensure of a long term application to your ladder.

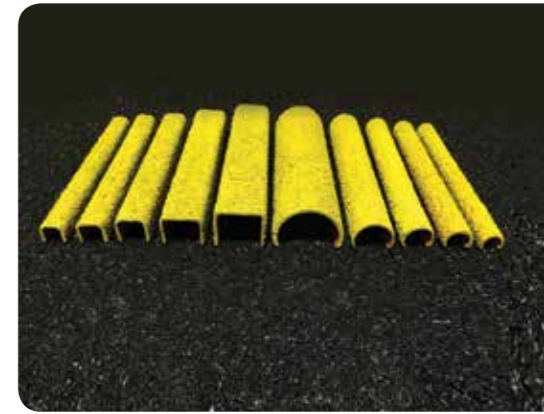



Anti-Slip Gangway Treads

SafetyGrip Solutions manufacture a wide range of anti-slip surfaces which are designed to be installed directly to marine vessel gangways. Quick and easy to install these heavy duty GRP tiles and profiled edgings will provide superb levels of grip and traction even in the harshest of operating conditions. SafetyGrip Gangway Tiles can be installed to all types of aluminium and timber gangways.

Benefits and Features

During high & low tide operations the steep pitch of a vessels gangway can become very hazardous for personnel ascending and descending, add in the poor weather conditions and you can find that aluminium or timber surfaces can become extremely slick & slippery. SafetyGrip Anti-slip Gangway Treads offer a quick and effective solution to increase traction and remove the hazard of slips and trips.

Applications

With such a variety of marine gangways in the market we typically manufacture each application independently to ensure each application is tailored to meet your exact specification. We offer a variety of designs and applications to cater for all types of gangway.

KEY FEATURES

- Heavy Duty/High Traction
- Non-Corrosive
- Reduce Slips, Trips & Falls
- Fully Guaranteed
- Easy Installation

SPECIFICATIONS

Sizes

Gangway Treads can be applied to the flat part of the gangway as well as the raised profile section; these can be supplied in either square box section or triangular/diamond style profiles.

A full range of standard and bespoke customised sizes are readily available.

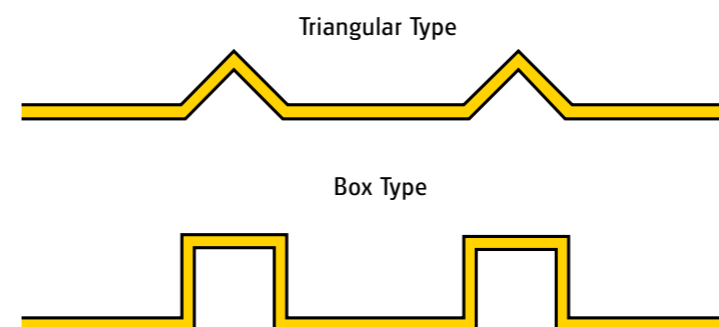

Colours

Typically supplied with a high visibility colouring - usually Yellow however a full range of custom colours are available on request.

Hazard Markings/Custom Logos

SafetyGrip Gangway Treads can incorporate various customised logos and safety hazard markings which are embossed on the surface of the product.

Anti-slip Grades

SURFACE GRADES	CODE	GRIT SIZE	APPLICATION
Fine	FG	2mm (1/16")	Light Industrial
Coarse	CG	4mm (3/16")	General Industrial

Installation

SafetyGrip Anti-slip Gangway Treads are easy to install, they can be fixed to most aluminium and timber gangways using conventional mechanical fixings & fasteners.

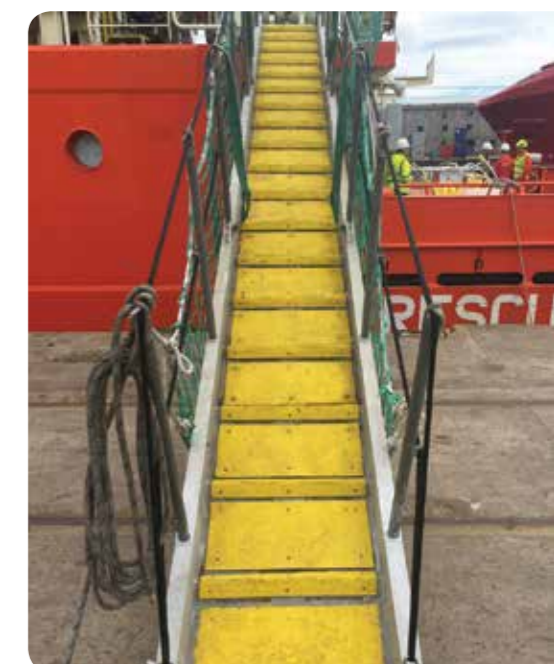



Anti-Slip Tape



Handrail Tape



Conformable Anti-Slip Tape

Anti-Slip Tape

Safety-Grip Anti-slip Grip Tape is designed to cover all types of flat surfaces which can be of a variety of materials & substrates, including steel, wood, concrete and plastics. Quick and easy to install it can instantly provide a non-slip surface to walk on.

Safety-Grip Anti-slip Tape is uniquely constructed using specialist abrasives materials onto a self-adhesive UPU carrier/backing. This ensures it is extremely hardwearing and durable product that is suitable for both internal and external applications.

Safety-Grip Anti-slip Tape is typically supplied in rolls. These can be produced in a number of standard sizes and colours and can include various safety/hazard identification markings as well as photoluminescent glow in the dark finishes.

Typical Applications

- Steps/Stairs
- Walkways/Gangways
- Containers
- Engines Rooms/Machinery Spaces
- Construction Equipment

Benefits

- Standard Colours
- Excellent High Traction
- Indoor & Outdoor Use
- Prevention of Slip, Trips and Falls
- Quick and Easy to Apply

Specification

Physical Data
 Colour: Various
 Finish: Supplied in Roll
 Anti-slip Grade: Coarse Grade
 Temperature range:
 -30 deg C to +60 deg C



STANDARD ROLL SIZING	
Metric	Imperial
25mm x 18.3m	1" x 60ft
50mm x 18.3m	2" x 60ft
100mm x 18.3m	4" x 60ft

Colours



Handrail Tape

Safety-Grip Anti-slip Handrail Safety Tape is constructed with a soft non-abrasive surface that can be easily cleaned using all available cleaning methods. It has the feel of a rubber product yet being plastic has superior dimensional stability.

Handrail Grip Tape can be instantly applied on external handrails as well as internal, this is due to the materials inability to retain water, preventing the surface freezing and causing discomfort for the user.

Safety-Grip Handrail Grip Tape is wrapped around a handrail in either an angled format or can be supplied to width by SafetyGrip allowing a custom made wrap for the circumference.

STANDARD ROLL SIZING	
Metric	Imperial
25mm x 18.3m	1" x 60ft
50mm x 18.3m	2" x 60ft
100mm x 18.3m	4" x 60ft

Colours



Typical Applications

- Internal Handrails
- External Handrails
- Machinery/Equipment Hand Holds

Benefits

- Standard Colours
- Excellent High Traction
- Easy Clean
- Indoor & Outdoor Use
- Quick and Easy to Apply

Specification

Physical Data
 Colour: Various
 Finish: Supplied in Roll
 Anti-slip Grade: Non abrasive
 Temperature range:
 -30 deg C to +60 deg C



Conformable Anti-Slip Tape

Safety-Grip Anti-slip Conformable Safety Tape is constructed with a soft aluminium self-adhesive foil backing which is then top coated with a thick spread of aluminium oxide grit making it hardy, tough, durable and long lasting.

The benefit of using Anti-slip Conformable Tape is that it is ideal for both shaped and uneven surfaces. Once the abrasive safety tape has been applied the conformable design adopts to the texture and shape of the durbar/chequer plate, as it is foil based it has no inherent memory so will not lift or rise off. The Safety Tape can withstand extreme temperature variations, even surviving temperatures below -30C. The unique flexibility of the product allows extreme flexures, even over 90 degree angles without damaging the product.

The range is available in a variety of colours and is most suitable for uneven surfaces.

STANDARD ROLL SIZING	
Metric	Imperial
25mm x 18.3m	1" x 60ft
50mm x 18.3m	2" x 60ft
100mm x 18.3m	4" x 60ft

Colours

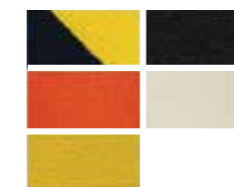

Typical Applications

- Durbar or Checker Plate
- Uneven or Angled Surfaces
- Handrails
- Machinery/Equipment
- Steps & Walkways

Benefits

- Standard Colours
- Excellent High Traction
- Indoor & Outdoor Use
- Prevention of Slip, Trips and Falls
- Quick and Easy to Apply

Specification

Physical Data
 Colour: Various
 Finish: Supplied in Roll
 Anti-slip Grade: Coarse Grade
 Temperature range:
 -30 deg C to +60 deg C



Service and Installation



SafetyGrip products are designed for ease of installation, they are aimed at offering almost immediate protection with very little or no downtime. Simple to install so they can be fitted by almost any semi-skilled persons without the need for any complicated tooling or equipment.

All our products are produced so they can be attached to your existing surfaces, substrates or structures, this can include concrete, timber, steel and FRP grating surfaces, All our products can be installed/secured with the use of mechanical fixings and fasteners, also with urethane adhesives.

Product Selection Sizing and Specification

The key to the most effective anti-slip product is in the selection and sizing; please consider the environmental conditions when choosing the type of product that best suits.

As guidance we would advise you consider the following: Volume of Traffic / Likelihood of Dirt & Grime to build-up / colours and markings / Site location / Fixing types & floor substrate (SafetyGrip Solutions will be happy to advise on any queries that you may have - just give us a call and let's talk)

Installation

SafetyGrip Products are typically supplied pre-cut and pre-drilled for ease of installation; this can aid the installation and reduce the fitting time. We strongly advise the use of SafetyGrip hardware/adhesives when installing the product - this will ensure suitable secure installation for long term use (we cannot accept responsibility for any damaged / ill-fitted product as result of using non conforming 3rd party fixings & adhesives).

Fitting Product onto Steel Grating / Grille

(Anti-slip Stair Treads / Grating Tiles / Pipe Ramps)

- Saddle Clip Assembly - consisting of M8x50 bolt - nyloc nut -saddle clip

Fitting Product onto Steel Plate (Chequered or Diamond plate)

(Anti-slip Stair Treads / Walkway Tiles / Pipe Ramps)

- Bolt Assembly - M8x30mm Bolt - Nyloc Nut - Washer
- Weld Assembly - SafetyGrip Specialist weld lugs
- Chemical Bonding - Urethane Adhesive/Sealant

Fitting product onto Concrete Surface

(Anti-slip Stair Treads / Walkway Tiles / Pipe Ramps)

- Hammer Fixing - 6.5 x 30mm

Fitting Product onto Wooden Surface

(Anti-slip Stair Treads / Walkway Tiles / Pipe Ramps)

- Screws - various sized wood screw available

Care and Maintenance

Once installed all SafetyGrip products should be regularly cleaned and maintained to ensure optimum performance, regular cleaning will ensure the product is kept looking like new for longer.

Regular cleaning with high pressure washers or bristle brushing will ensure the surface stays free from any dirt or grime, this can be accompanied by most household detergent or cleaners for any stubborn deposits.

Site Service

A little unsure on exactly what you require or how to install! Then why not let SafetyGrip take care of this for you.

We have a team of fully qualified technicians whom can come onsite and advise on all aspects from product selection through to installation. This can include full technical site surveys to gather all the relevant sizing and information, through to full product work site installation. Our team has many years of experience and will ensure all work is carried out safely and in a timely manner without causing any disturbance to your ongoing operations. We can operate Onshore / Offshore, Domestic or internationally so please give a call to see how we can help.

Product Surfaces



Technical Information

Product Solutions

SafetyGrip's products are designed primarily for the Marine and Offshore Environment, for this reason it is essential that our products are non-corrosive and have excellent fire retardant properties. SafetyGrip have gained the reputation for manufacturing and producing some of the toughest and most hard-wearing products available in today's market; with exceptional impact resistance and high traction qualities these products will continue to provide superb anti-slip surfaces even after many years of use.

SafetyGrip Solutions offer a wide range of standard and customised anti-slip products - our range includes heavy duty solutions for Stairways / Walkways / Decks / Drill Floors / Access Ramps / Ladders and Pipe Ramps. We have the unique capability to manufacture customised products to a variety of different shapes, sizes, colour and grades - we welcome you to put us to the test with your specific requests!

Product Construction

SafetyGrip use a wide range of materials to produce our anti-slip products, this includes a full range of FRP (Fibre reinforced plastic) products that use the latest resin technology including Isophthalic polyester resins. These FRP composite based products provide excellent strength, durability and longevity. They each incorporate our high traction surfaces into the FRP core that have proven to offer anti-slip properties that simply can't be matched by traditional gritted paints and tapes. All our Stair Treads / Ladder Rung Covers / Walkway Tiles and Pipe and Hose ramps incorporate this technology.

Our product range also includes a selection of heavy duty polyurethane based products that again offer excellent chemical and fire retardancy properties. These HD Urethane products are custom moulded using the latest polyurethane polymers which provide superb tear and tensile strength. These PU systems can be used to manufacture a wide range of products including Deck Mats / Drill Floor Matting / Pipe Matting and Pipe Chocking Systems.

Sizes

SafetyGrip currently offer a full range of standard sizes across all our range. We also offer full facilities to custom manufacture bespoke applications that are aimed to your specific size or needs!

Surface Grading

We manufacture our products with either one of 3 separate surfaces, (Fine Grade / Course Grade / Extra Course Grade) whether it's glossy painted surfaces or heavily soiled area we have a suitable surface to solve your problem.

Structural Strength & Durability

Although all our products are of heavy duty construction - they are not designed to be load bearing, please ensure they are attached to suitable underlying structure when being installed. (With exception to our pedestrian Pipe and Hose Ramps which have a 250kg load capacity)

Fire Resistance

All SafetyGrip products have been Fire Resistance tested to ensure they meet industry standards

BS476 part 7 to a class 2.

EN ISO 9239

ISO 11935

Friction Test

All friction tests have been carried out using the Pendulum CoF test. (Coefficient of Friction). Guidelines show that a result above 0.6 is considered suitable and classed as a high traction anti-slip surface. These tests show the following results.

FLOOR SURFACE AND CONDITIONS	COF RESULTS
Steel/Timber Floor Surface - Dry	0.2 - 0.4
Steel/Timber Floor Surface - Wet	0.1 - 0.25
SafetyGrip Anti-slip Surface	0.75 - 0.85

(Reading of 0.1 is considered poor / Reading of 0.9 is considered excellent)

Colour Options

SafetyGrip offer a wide range of colour options which include single colour or two tone finishes, These two tone contrasting finishes are particularly beneficial for highlighting the leading edge of the tread, or for highlighting walkway access and egress routes.

Standard Colours Include: (Yellow / Red / Green / Black and Yellow / Blue / Grey / Black / Fluorescents Yellow and Orange / Photoluminescent) We can also colour match most colours from the RAL or BS colour charts.

As well as standard colour finishes we can also incorporate our Hi-Glo colour coding systems, these photoluminescent finishes can be applied to any of the products and will provide a glowing finish for several hours should your lights go out - excellent for highlight escape routes (note: photoluminescent coatings need to be charged by a suitable light source before they will emit a glow)

Hazard Identification / Markings and Logos

Why not reinforce your safety messages or corporate logo's by incorporating them onto the product, SafetyGrip can supply our full range of products which can be tailored to meet your specific requirements - these include logos, symbols and hazard identification markings and text. Multiple styles and colours help reinforce the message.

Installation

All our products are designed for ease of installation. (We strongly advise the use of SafetyGrip hardware/adhesives when installing product - we cannot accept responsibility for any damaged / ill-fitted product as result of using non conforming 3rd party fixings and adhesives).



Safety Grip Solutions Limited
Unit 1 Cairnrobin Pipeyard
Marywell
Portlethen
Aberdeen
AB12 4SB
UK

info@safetygripsolutions.com
Tel: +44 (0)1224 784700
www.safetygripsolutions.com